

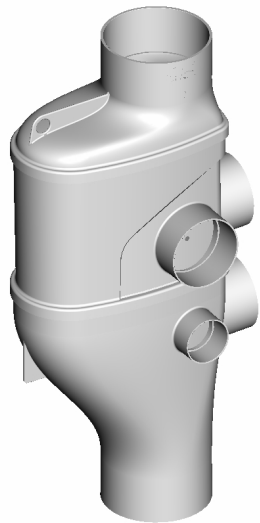

Stack Diverter

Reduced Velocity Aerator Stack System (RVASS)

ID:
19001



- Made from PVC
- Fully complies to AS3500 RVASS standards. No third party certification required
- Fully Watermark approved
- Connections are FI, designed to be solvent welded to 150mm DWV pipe
- Minimal ceiling space required, with 100mm branches at highest possible point on fitting
- No access panels required for maintenance
- No machine or offsite welding required

ID	Ø (MM)	CTN QTY
19001	150	1

Measurements (mm)

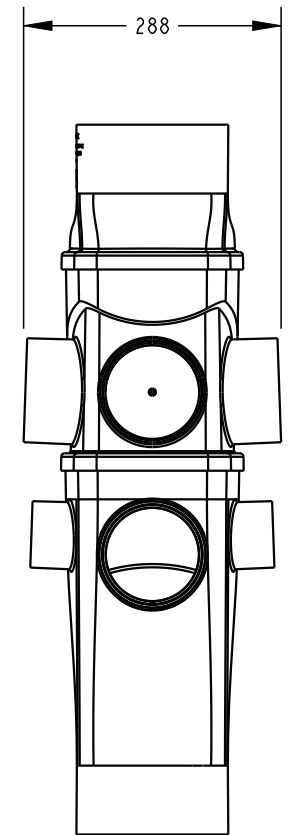
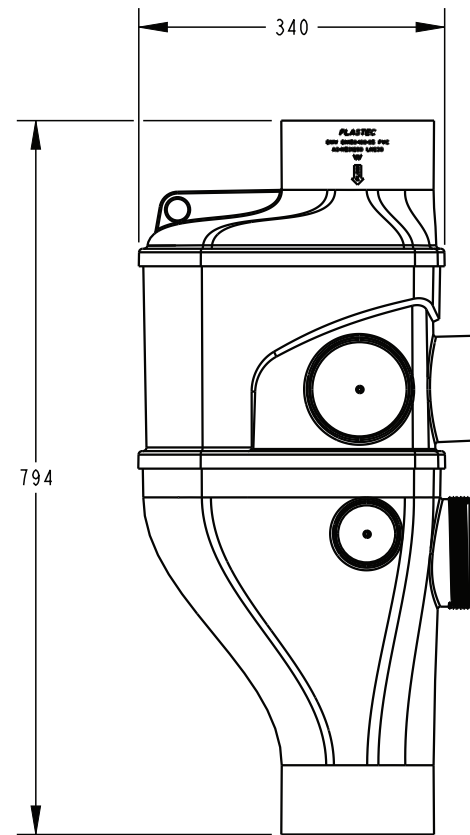

07 5413 4444 - www.plastec.com.au
 JUDE PHOON - SPECIALIST
 0437 610 967

Specifications are correct as at 11/10/2023, but are subject to change at any time without notice.

